

***Reference Bill of Materials on Page 4**

STEM LENGTH WILL VARY. ORDER SEPARATELY
 MP SW 3/8 EX RD MAG ADJ USED WITH STEM
 3/8" IP O.D. PH
 3/8" IPS .625"-.635" O.D. 18 T.P.I.
 Add Suffix WHT for White or BK for Black

***38° SWIVEL**

This Document
 Contains Proprietary
 Data that is property
 of Pendant Systems
 which reserves all
 rights to it.
 Unauthorized use
 without authorization
 is prohibited.

Pendant Systems

1670 Winchester Rd.
 Bensalem, PA 19020
 P-215-638-8552
 F-215-638-8554
www.PendantSystems.com

UNLESS OTHERWISE SPECIFIED DIMENSIONS ARE IN BOTH INCHES & MILLIMETERS UNLESS OTHERWISE NOTED TOLERANCES:

LINEAR: XX= .02" XXX= \pm .010" ANGULAR: \pm 1 Degree

FINISH:

TITLE:

MP SW 3-8 EX RD MAG ADJ

DO NOT SCALE DRAWING

MATERIAL:

Part #

DEBUR AND BREAK SHARP EDGES

REVISION

DRAWN DATE: 5/9/17

Drawn By: MWR

SCALE: NTS

SHEET 1 OF 4

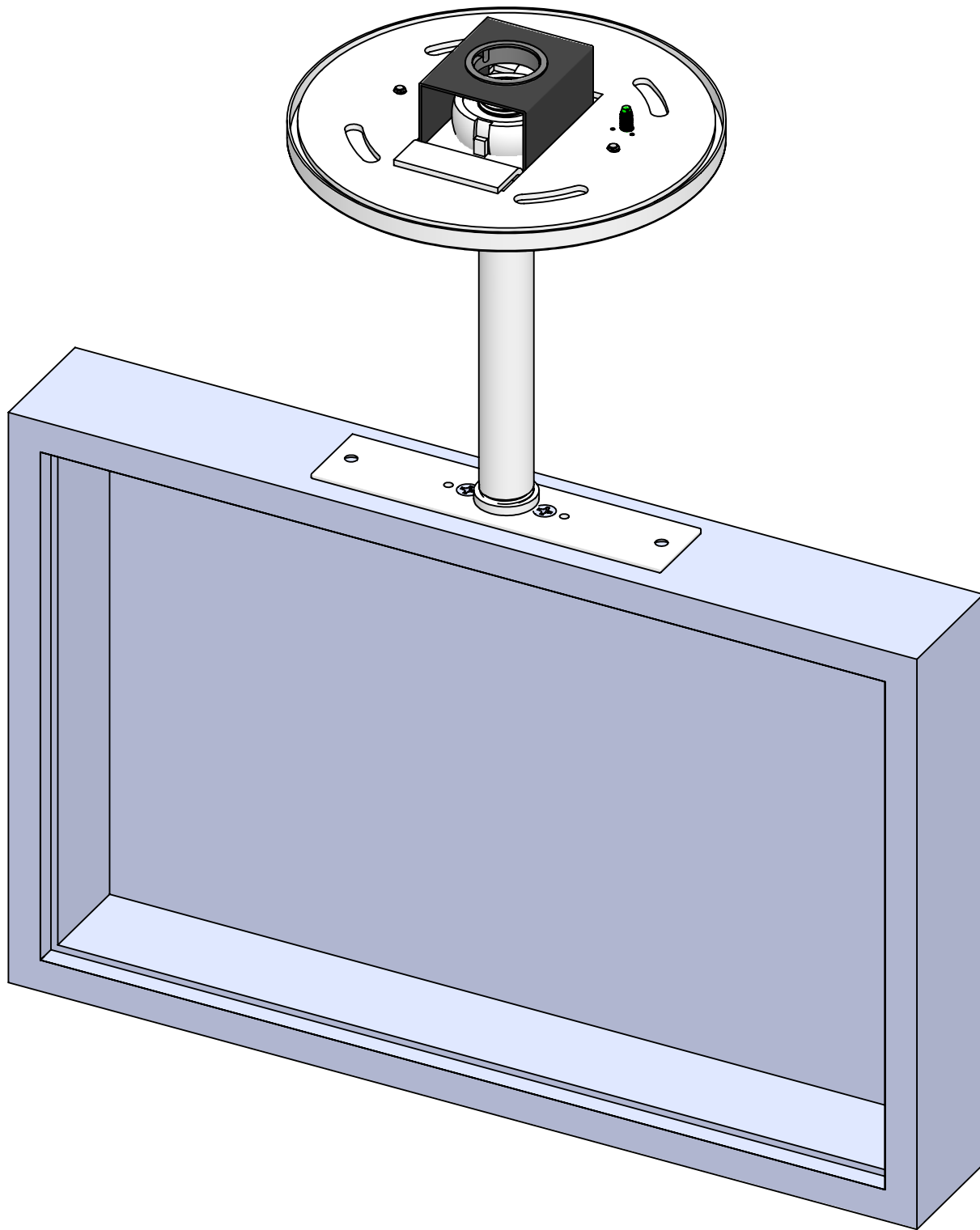

This Document
Contains Proprietary
Data that is property
of Pendant Systems
which reserves all
rights to it.
Unauthorized use
without authorization
is prohibited.

Pendant Systems

1670 Winchester Rd.
Bensalem, PA 19020
P-215-638-8552
F-215-638-8554
www.PendantSystems.com

UNLESS OTHERWISE SPECIFIED DIMENSIONS ARE IN BOTH INCHES & MILLIMETERS UNLESS OTHERWISE NOTED TOLERANCES:

LINEAR: XX= .02" XXX= \pm .010" ANGULAR: \pm 1 Degree

FINISH:

TITLE:

MP SW 3-8 EX RD MAG ADJ Assembled

DO NOT SCALE DRAWING

MATERIAL:

Part #

DEBUR AND BREAK SHARP EDGES

REVISION

DRAWN DATE: 5/9/17

Drawn By: MWR

SCALE: NTS

SHEET 2 OF 4

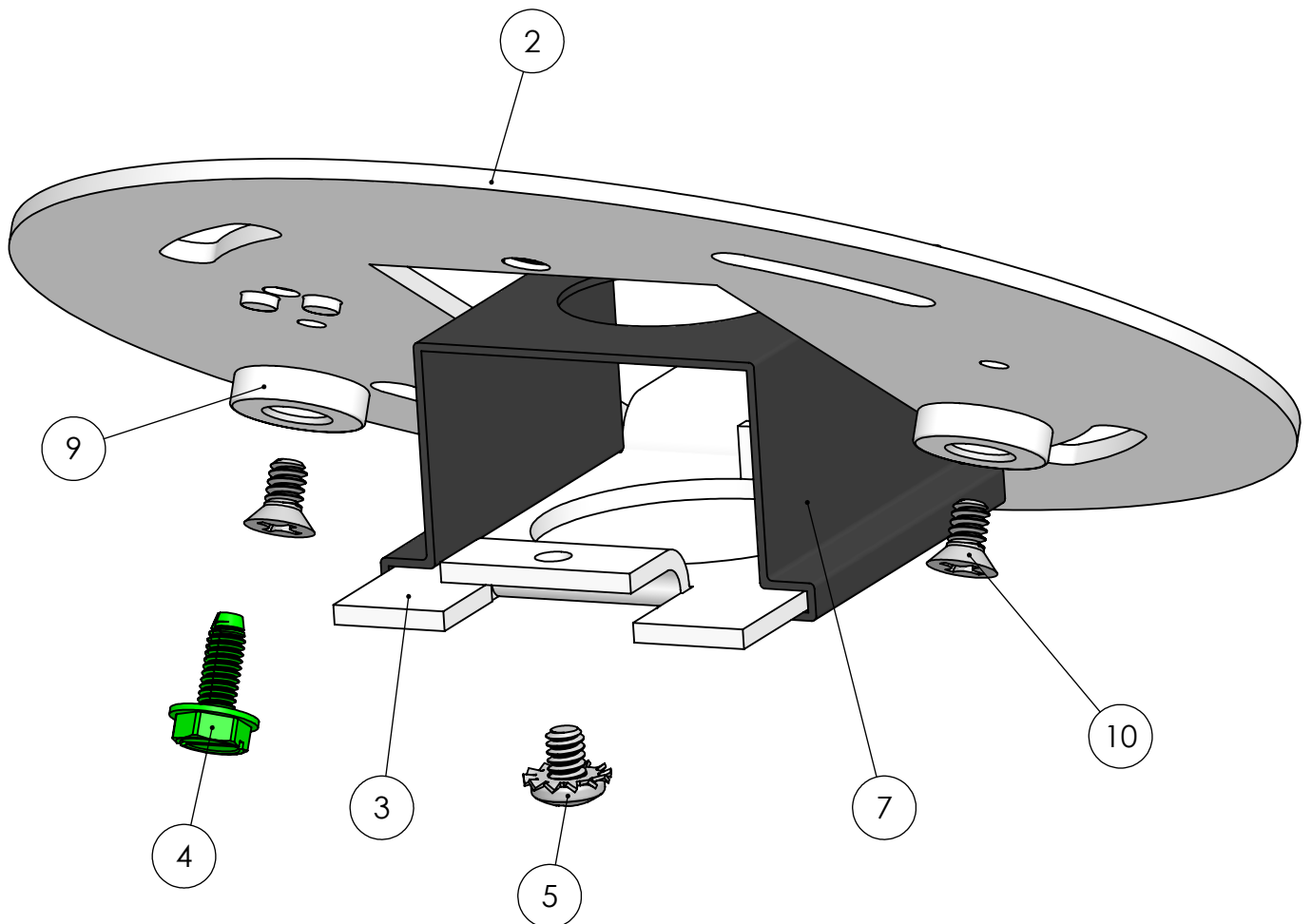

This Document
Contains Proprietary
Data that is property
of Pendant Systems
which reserves all
rights to it.
Unauthorized use
without authorization
is prohibited.

Pendant Systems

1670 Winchester Rd.
Bensalem, PA 19020
P-215-638-8552
F-215-638-8554
www.PendantSystems.com

UNLESS OTHERWISE SPECIFIED DIMENSIONS ARE IN BOTH INCHES & MILLIMETERS UNLESS OTHERWISE NOTED TOLERANCES:

LINEAR: XX= .02" XXX= $\pm .010"$ ANGULAR: ± 1 Degree

FINISH:

TITLE:

MP SW RD MAG Instruction

DO NOT SCALE DRAWING

MATERIAL:

Part #

DEBUR AND BREAK SHARP EDGES

REVISION

DRAWN DATE: 5/9/17

Drawn By: MWR

SCALE: NTS

SHEET 3 OF 4

ITEM NO.	PART NUMBER	DESCRIPTION	QTY.
1	276	5" Round w/ 1.18" CH	1
2	MP Crossbar Round	4.75" Round Crossbar .080" Material Thickness Zinc Plated Steel	1
3	MP Plate HB	Monopoint Plate for Half Ball for MP Crossbar 2.82" L x 1.650" W x .075" Material Thickness Half Ball Opening for #35,#34 and #147 Tapped 8/32" Hole Zinc Plated Steel	1
4	#32	8/32 Green Ground Screw	1
5	183	8/32" x 1/4" Philip Head Ext Sems Steel Zinc Screw	1
6	#34ADJ	3/8" IP Slip Half Ball Bright Casting	1
7	MP Swivel Clip	Mono Point Swivel Retaining Clip for MP-Plate HB Spring Steel	1
8	#237	.875" Hole Bushing .945" W x .750" I.D. x .250" H .063" Max Panel Thickness	1
9	Magnet	#6 & #8 Magnet	2
10	271	6/32" x 1/4" L Flat Head Philips Machine Screw	2
11	#SSS	1/4" -20 Socket Set Screw w/.125 DIA & 1/8" Allen Hex Head Pin for ADJ Series Half Balls	1
12	#ADJ-SS	1/4" -20 Short (.350" Long) Socket Set Screw w/.125" DIA Point & 1/8" Allen Hex Head Pin for ADJ Series Half Balls	1
13	Exit Bracket 3-8 IP	Exit Bracket with 3/8" IP tapped center hole & 6/32" tapped holes. 4.5" x .875" (Available in white, nickel and black)	1
14	Exit Base	Exit Bracket Base 6/32" Slip & Tapped Holes. 2" x .875" Zinc Plated	1
15	Exit Bracket Screws	6/32" Screws	2

This Document Contains Proprietary Data that is property of Pendant Systems which reserves all rights to it. Unauthorized use without authorization is prohibited.

Pendant Systems

1670 Winchester Rd.
Bensalem, PA 19020
P-215-638-8552
F-215-638-8554
www.PendantSystems.com

UNLESS OTHERWISE SPECIFIED DIMENSIONS ARE IN BOTH INCHES & MILLIMETERS UNLESS OTHERWISE NOTED TOLERANCES:

LINEAR: XX= .02" XXX= \pm .010" ANGULAR: \pm 1 Degree

FINISH:

TITLE:

Bill of Materials

DO NOT SCALE DRAWING

MATERIAL:

Part #

DEBUR AND BREAK SHARP EDGES

REVISION

DRAWN DATE: 5/9/17

Drawn By: MWR

SCALE: NTS

SHEET 4 OF 4