

\*FLASH PLATE ATTACHED TO #33 CROSSBAR

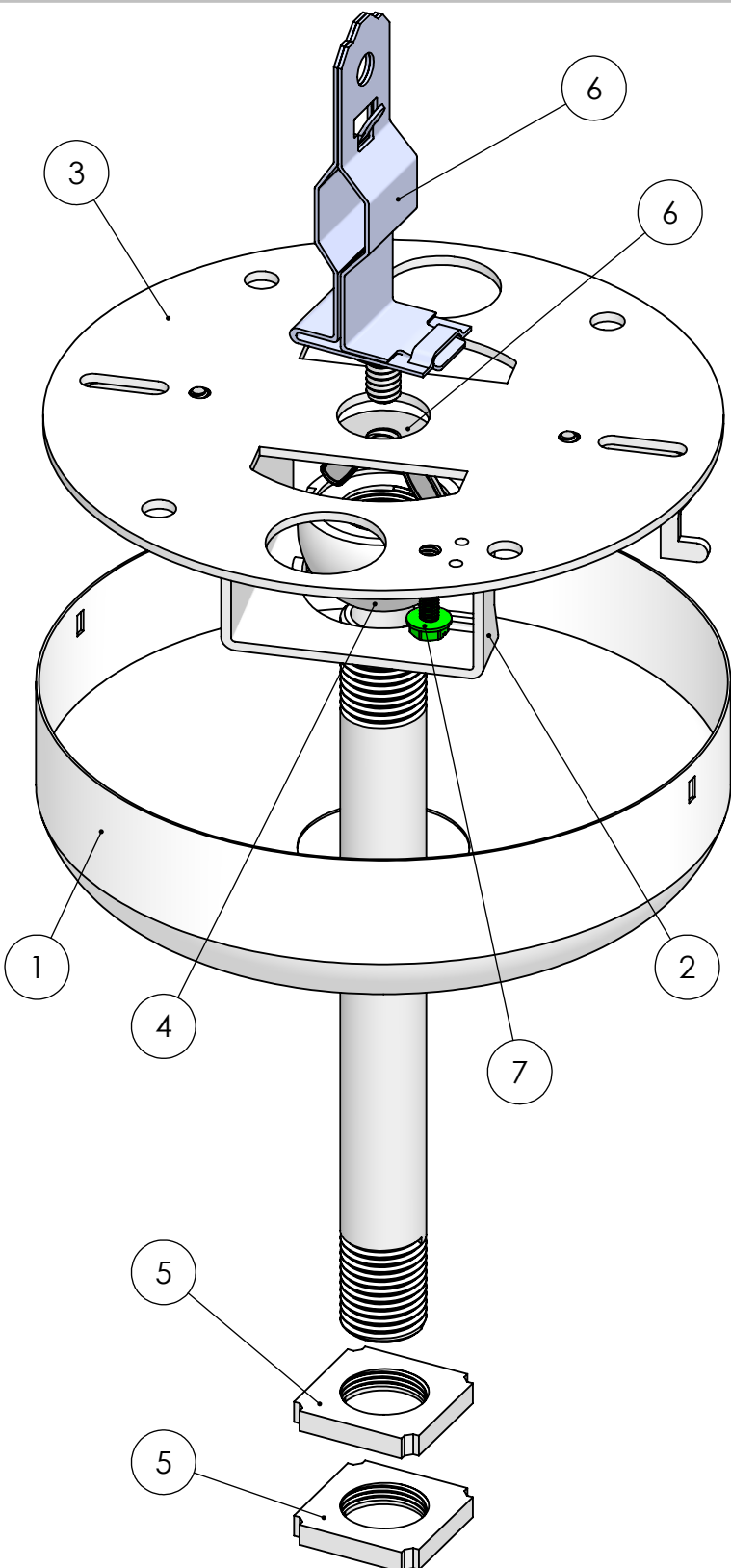

ITEM NO.	PART NUMBER	DESCRIPTION	QTY.
1	#43	5" Diameter x 1 1/2" H White 1 1/4" Center Hole with side slots for #33	1
2	#33	Swivel Crossbar for #34, #35, #147, & #272 ADJ Half Balls. 2" W x 4 7/8" L x 1 3/8" H x 14 Gauge	1
3	Flash Plate	4.94" DIA x .076" Zinc Plated .675" DIA Center Knockout & two Oval Shaped Knockouts for Wiring into J-Box 2- 1/2" IP (.875") side hole Knockouts 4- 1/4" IP Mounting Holes & 2- 8/32 tapped holes for Mounting Crossbar to plate Ground & 2-8/32" mounting screws included	1
4	#34	3/8" IP Tap Half Ball	1
5	#22	3/8" IP x 1 1/16" Square x .073" Thick Zinc Plated	2
6	#110	1/4"-20 Stud 3/8" L Support Clip for T-Bar W/Winged Locknut Wraps around Acoustical T-Bar Grid	1
7	#32	8/32 Green Ground Screw	1

**STEM LENGTH WILL VARY. ORDER SEPARATELY**  
**C545 FP DC USED WITH STEM 3/8" IP**  
**3/8" IPS .625"-.635" O.D. 18 T.P.I.**

\*38° SWIVEL

This Document Contains Proprietary Data that is property of Pendant Systems which reserves all rights to it. Unauthorized use without authorization is prohibited.

**Pendant Systems**  
 1670 Winchester Rd.  
 Bensalem, PA 19020  
 P-215-638-8552  
 F-215-638-8554  
 www.PendantSystems.com

UNLESS OTHERWISE SPECIFIED DIMENSIONS ARE IN BOTH INCHES & MILLIMETERS UNLESS OTHERWISE NOTED TOLERANCES: LINEAR: XX= .02" XXX= ±.010" ANGULAR: ± 1 Degree		FINISH:	TITLE: <b>C545 FP DC</b>
DO NOT SCALE DRAWING	MATERIAL:	Part #	REVISION
DEBUR AND BREAK SHARP EDGES		SCALE: NTS	SHEET 1 OF 1
DRAWN DATE: 6/15/16	Drawn By: MWR		